

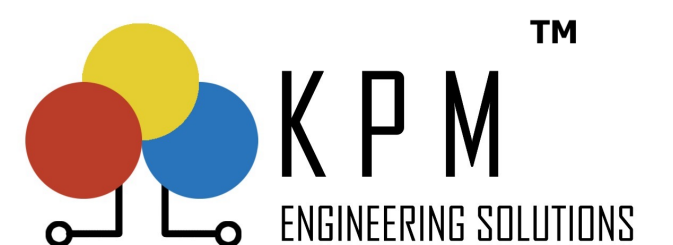

KPM CT/PT Analyzer

A ground breaking all in one solution for testing of CT / PT





Traditional Setup (Example)



Primary Injection Kit & Cable



AC Hipot

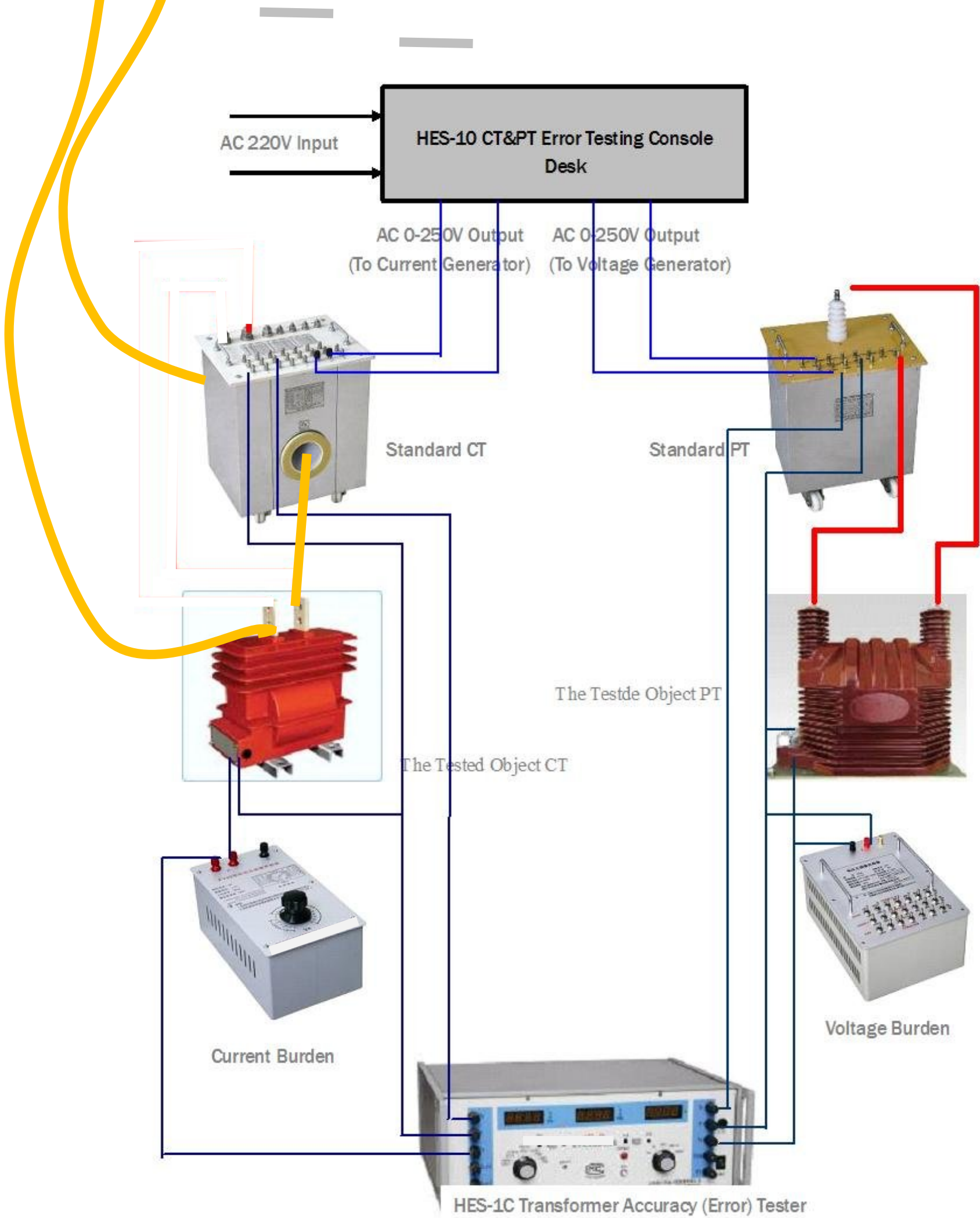

Polarity Tester



Knee Point Tester



Winding Resistance Tester

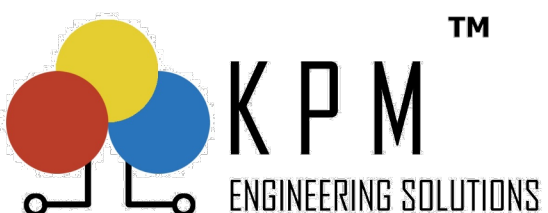



KPM CT/PT Analyzer

KPM-CT/PT Analyzer is an all in one solution for testing all type of CT/PT as per IEC standards. It is an equipment with high ROI (Return On Investment) . Below features make KPM CT/PT analyzer and ideal tool for CT/PT Manufacturer , Testing labs , Substations (Upto 765KV) , Power Plants etc.

1. **Low Testing Time**
2. **Simple connection**
3. **Highest Accuracy**
4. **Portable & Light Weight**
5. **High Interference Rejection**

(Completes all basic test for CT Winding & Cores in few minutes)
 (Simple one time connection)
 (0.05% for turns ratio & winding resistance)
 (< 15KG)
 (Can be used in 220/400/765 KV Live Switchyards)

Highlights:

A compact 15kg unit with complete measurement function, it can test all types of current/potential transformer for:

Tests for Current transformer:

- Excitation curve and parameters test
- Turns ratio test
- Ratio and phase error test
- Polarity mark check
- Coil resistance measurement
- Secondary loop burden measurement
- Error line curve test for protection CT
- Transient CT parameters test
- CT nameplate guess
- Saturation hysteresis loop curve measurement

Tests for Voltage transformer:

- Turns ratio and phase angle error test
- Polarity test
- Secondary burden test
- Winding resistance test

Voltage measurement

Range: 0~200V (auto change range in 1V/10V/70V/200V)
 Error: < ±0.1%+0.01%FS

Test standards :

IEC60044-1,
 IEC60044-6,
 C57.13
 IEC 61869-2,3

Turns ratio measurement

- Range: 1~35000 ,
- 1~2000 error<0.05% , 0.02% typ
- 2000~5000 error>0.1% , 0.02% typ
- 5000~35000 error<0.2%

Maximum knee voltage measurement

45kV

Phase Displacement

Resolution 0.01 min
 Accuracy 1 min (typical) /3 min (guaranteed)

Winding Resistance

Resolution 1 mΩ
 Accuracy 0.05% (typical)/0.1% (guar)
 Range 0-160 Ω (Auto Range)

Physical Dimensions

Size (WXHxD) in mm 485 X 356 X 183
 Weight < 15Kg

Working condition

Temperature -10°C ~ 50°C (Operational)
 -25°C ~ 70°C (Storage)

Humidity

≤90% (not condensing)

Certificates From Ext Labs (Optional)

Wuhan HV Research Report
 KEMA Report

Specifications

Input Supply

Voltage AC220V±10%
 Frequency 50/60Hz±10%
 Power 500VA

Output Supply

Voltage 0.1~180V (AC)
 Current 0.001~5A (RMS)
 VA 500VA

Maximum knee voltage Upto 45kV

Current measurement: Range: 0~10A (auto change range in 0.1/0.4/2/10A)
 Error: <±0.1%+0.01%FS



KPM CT/PT Analyzer

Traditional Method V/s KPM-CT/PT Analyzer:

Mobility & Time:

Traditional Method:

- Tons of equipment (Primary Injection Kit, huge cables, current boosters, burden box etc.)
- Takes Whole day for testing a CT with numerous change of connections increasing mistakes .

KPM-CT/PT Analyzer:

- <15kg, ideal for handling on-site
- Simple test connections with automatic schedule completes all the basic tests in few minutes .

Accuracy:

Traditional Method:

- High accuracy, but complicated wiring makes testing error-prone.

KPM-CT/PT Analyzer:

- Measurement of class 0.1 metering CTs
- Turns Ratio Accuracy of 0.05%
- Excellent noise suppression in charge substations of 220KV ,400KV & 765KV

Safety:

Traditional Method:

- Uses dangerously High Voltages & Currents (primary nominal current injection)

KPM-CT/PT Analyzer:

- Capable of testing all the parameters with maximum output voltage of 180V

Handling:

Traditional Method:

- Several people required to set up and conduct the test.

KPM-CT/PT Analyzer:

- One step test determining all key parameters evaluation(<5min)
- Quick word document preparation with adequate graphs

Reveal the Power of “30CM” TFT-Touch Screen



KPM-CT/PT Analyzer

Standards Complied:

KPM-CT/PT Analyzer perform automatic assessment of CT as per below standards -:

- IEC 60044-1
- IEC 60044-6
- C57.13
- IEC 61869-2,3

IEC60044-1 IEC60044-6 C57.13

0.1 0.2 0.2S 0.5 0.5S 1

3 5 5P 10P 5PR 10PR PX

IEC60044-1 IEC60044-6 C57.13

TPS TPX TPY TPZ

IEC60044-1 IEC60044-6 C57.13

0.15 0.15S 0.3 0.6 1.2

C X T

Excitation Curve:

Excitation Curve plotting as per IEC60044-1, IEC60044-6. Excitation Curve is a graph showing the relation between excitation current and secondary terminal voltage.

As per IEC 60044-1 Knee Point Voltage is defined as minimum sinusoidal e.m.f.(r.m.s.) at rated power frequency when applied to the secondary terminals of the transformer, all other terminals being open-circuited, which when increased by 10 % causes the r.m.s. exciting current to increase by no more than 50 % .

KPM-CT/PT Analyzer can attain a highest Knee Voltage of 45kV, by decreasing the frequency accordingly .

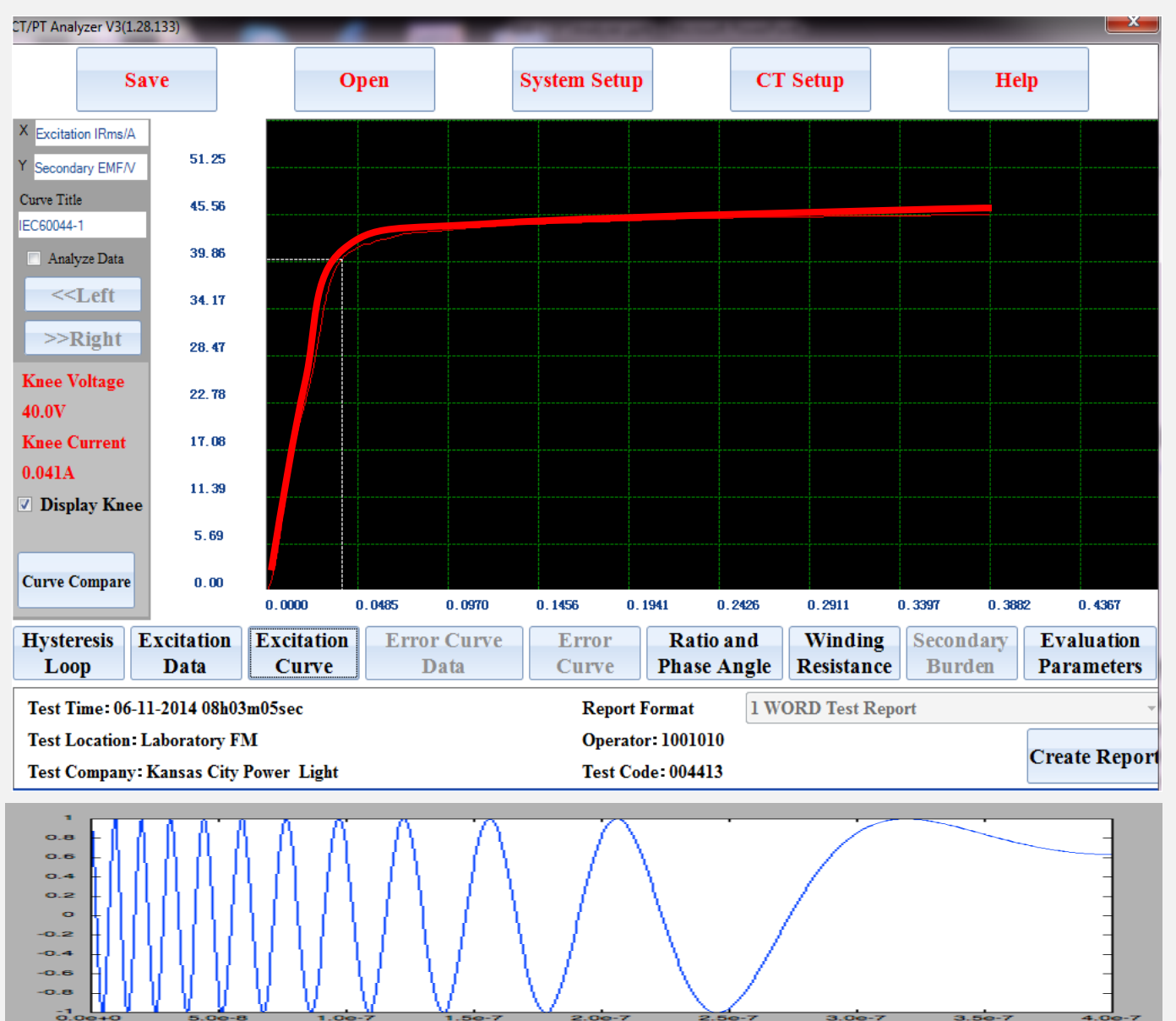
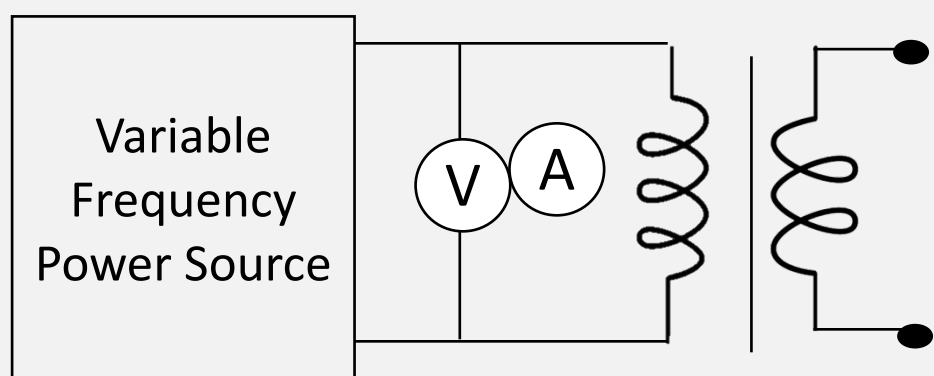

Ratio Error & Phase Error :

Ratio error ,Phase error & Turns Ratio error are calculated on the basis of extrapolation method which eliminates the use of an extra standard CT or standard load.

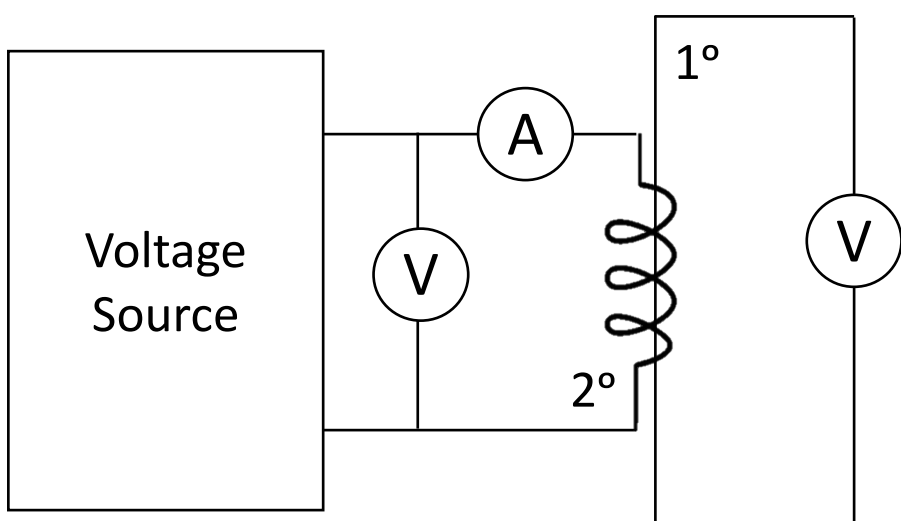

KPM-CT/PT Analyzer finds the Ratio & Phase error at Rated & Working Burden

CT/PT Analyzer V3(1.28.133)

Save Open System Setup CT Setup Help

Test Parameters and Standards

Rated Pri Current 1200.0 A Rated Sec Current 1 A

Standard IEC60044-1 Frequency 50 Hz

Turns Ratio and Polarity

Turns Ratio 1198.4:1 CT Polarity

Turns Ratio Error 0.13% Same Polarity (-)

Ratio and Phase Angle Error at Rated Burden

Rated Burden 40.00 VA Power Factor 0.80

1% Rated Current	Ratio Error (%)	Phase Error (Min)
1%	-0.65%	15.50'
5%	-0.51%	21.06'
20%	-0.07%	3.17'
50%	-0.17%	9.52'
100%	-0.08%	4.15'
120%	-0.04%	3.31'

Ratio and Phase Angle Error at Working Burden

Working Burden 10.00 VA Power Factor 0.80

1% Rated Current	Ratio Error (%)	Phase Error (Min)
1%	-0.37%	17.47'
5%	-0.27%	20.90'
20%	0.00%	5.35'
50%	0.06%	1.90'
100%	0.08%	1.20'
120%	0.08%	1.11'

Hysteresis Loop Excitation Data Excitation Curve Error Curve Data Error Curve Ratio and Phase Angle Winding Resistance Secondary Burden Evaluation Parameters

Test Time: 12-16-2014 05h35m07sec Report Format 1 WORD Test Report
Test Location: GW-LAB Operator: KUNAL
Test Company: GREEN-WATT Test Code: 002844 Create Report

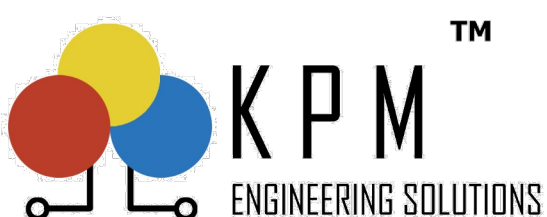

KPM-CT/PT Analyzer

Winding Resistance $R_{ct}@ 75^{\circ}C$:

KPM-CT/PT Analyzer finds the winding resistance value at Room temperature . Its inbuilt temperature sensor records the room temperature and provides the corresponding resistance value @75°C.

If the calculated value is less than name plate value as per IEC Standard the CT is evaluated pass else fail.

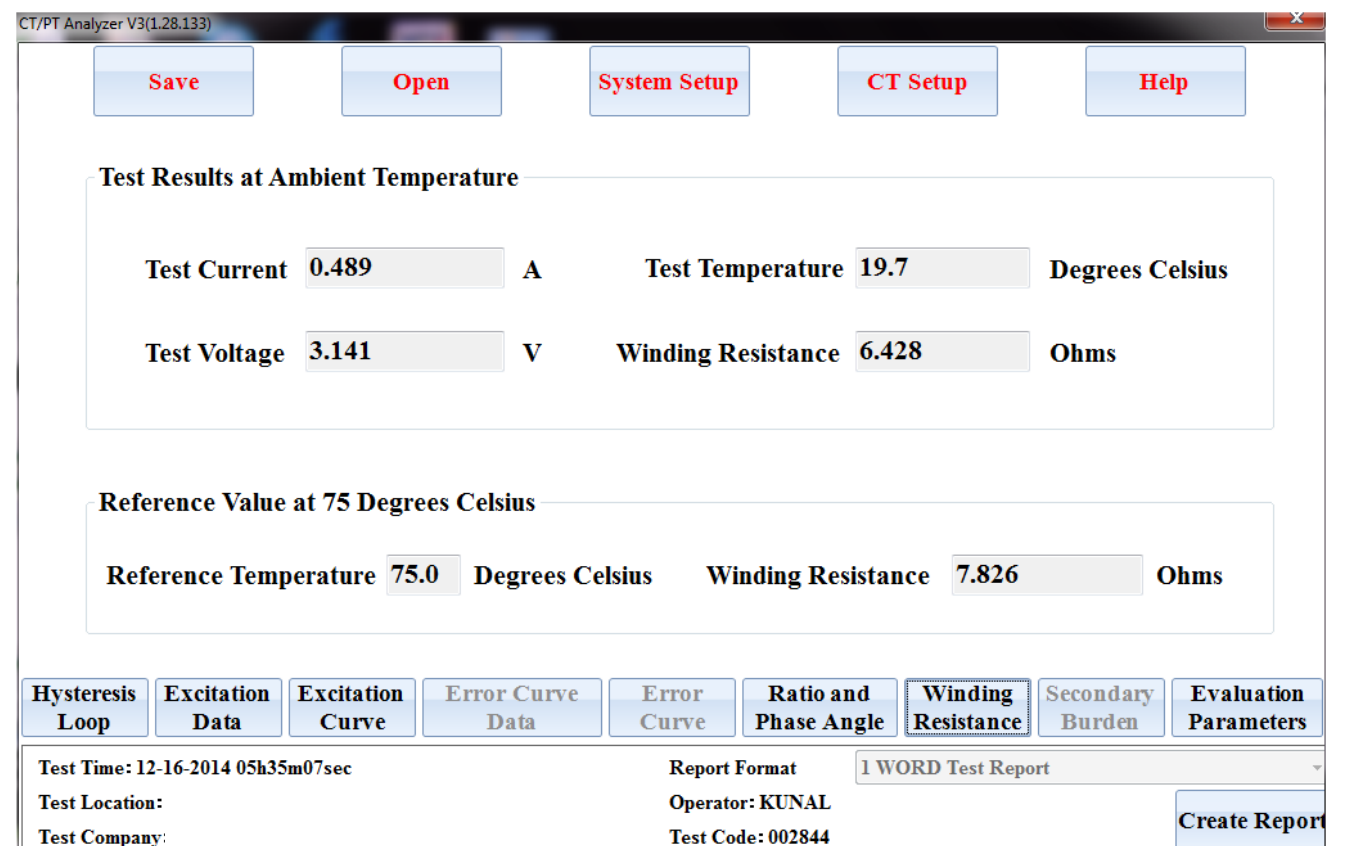

Error Curve :

This parameter is valid in IEC60044-1 protection CT . KPM-CT/PT Analyzer calculate 5% or 10% error line curve according to the selection of this item

The X coordinates of error curve is maximum burden value allowed. The Y coordinates of error curve is the times of rated primary current. If the value of secondary burden over than the maximum value in error curve the ratio error of sample CT would over than 10%(or 5%).

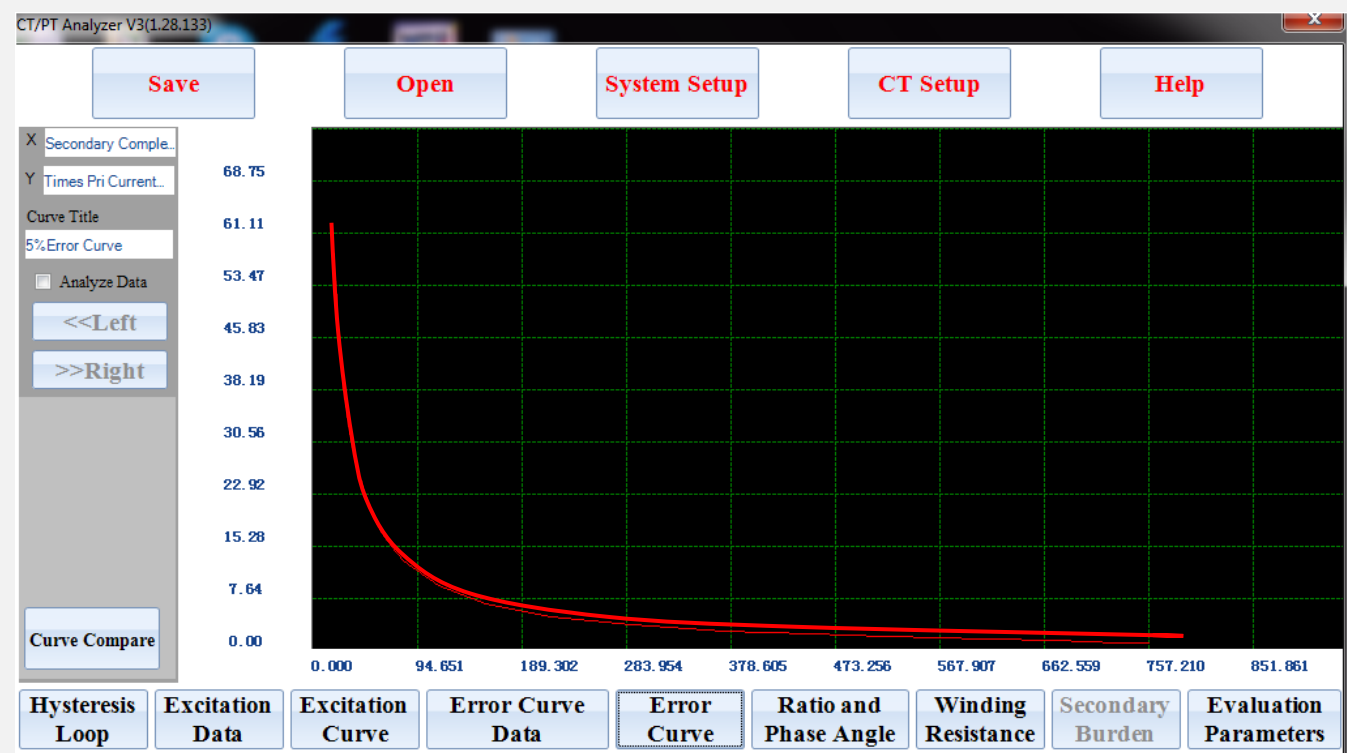

Hysteresis Loop:

KPM-CT/PT Analyzer is having an option of finding Saturation hysteresis loop curve which is measured in a constant frequency sine voltage. The test frequency is listed on the left of the panel. The X coordinates of the curve is the instantaneous current value and the Y coordinates of the curve is the core flux value.

Residual magnetism, or remanence, has a large impact on transient performance. The cause of the problem is that all magnetic materials display some degree of hysteresis. The manifestation of this is that as flux in the core is not reduced to zero when the excitation stops, a portion of the flux remains in the core as residual magnetism. This can be seen from the core's hysteresis curves. This function is highly helpful to CT manufacturers for finding defect of CT core in early steps of manufacturing.

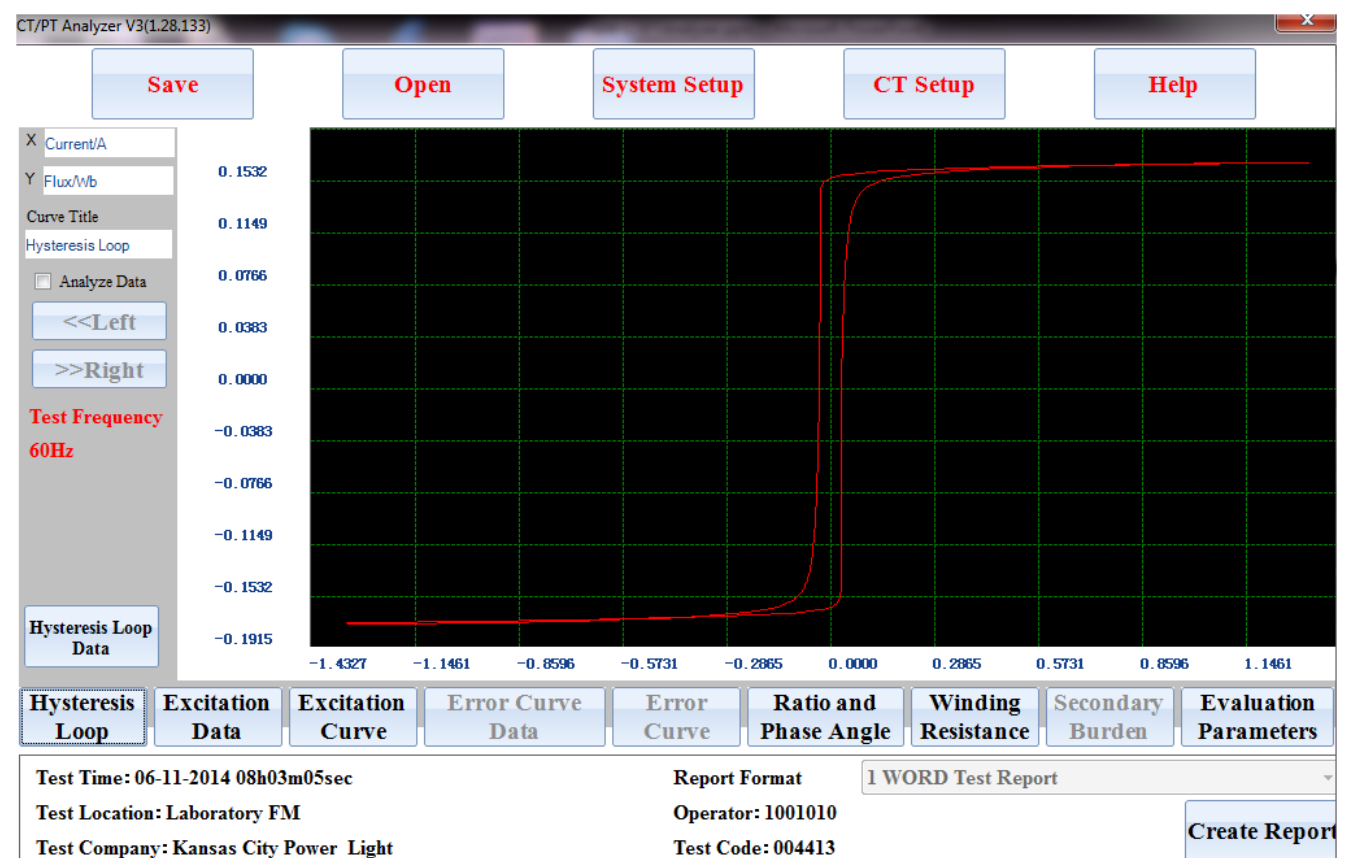

KPM-CT/PT Analyzer

CT/PT Evaluation :

CT/PT analyzer provides the automatic assessment of CT as per IEC Standards in term of "Pass" & "Fail"

- IEC 60044-1
- IEC 60044-6
- C57.13
- IEC 61869-2

In Evaluation Screen the test result parameters are compared with the name plate parameters as per relevant Standard .

The failed parameter is identified & is shown clearly by Red color .

Calculation Parameters		Value	Calculation Parameters		Value
Instrument Security Factor FS at Rated Burden	15.8	15.8	Saturation Conductor Ls	18mH	18mH
Secondary Loop Time Constant Is at Rated Burden	0.850s	0.850s	Un-saturation Conductor Lm	33.78H	33.78H
Instrument Security Factor FS at Working Burden	41.9	41.9	Remanence Flux Kr	85.5%	85.5%
Secondary Loop Time Constant at Working Burden	2.136s	2.136s			

Evaluation Parameters		Evaluation Standards	Results
Instrument Security Factor FS at Rated Burden 15.8	Instrument Security Factor from Nameplat...	Instrument Security Factor from Nameplat...	Pass
Ratio Error at 5%,20%,100%,120% Rated Current at Rated Burden(-0.51%,-0.07%,-...	Maximum Error 0.75%,0.35%,0.20%,0.20%	Maximum Error 0.75%,0.35%,0.20%,0.20%	Pass
Phase Error at 5%,20%,100%,120% Rated Current at Rated Burden(21.06',3.17',4.15'...	Maximum Error 30',15',10',10'	Maximum Error 30',15',10',10'	Pass
Ratio Error at 5%,20%,100%,120% Rated Current at 25% Rated Burden(-0.27%,0.00...	Maximum Error 0.75%,0.35%,0.20%,0.20%	Maximum Error 0.75%,0.35%,0.20%,0.20%	Pass
Phase Error at 5%,20%,100%,120% Rated Current at 25% Rated Burden(20.90',5.35'...	Maximum Error 30',15',10',10'	Maximum Error 30',15',10',10'	Pass
Instrument Security Factor FS at Working Burden 41.9	Instrument Security Factor from Nameplat...	Instrument Security Factor from Nameplat...	Pass
Ratio Error at 5%,20%,100%,120% Rated Current at Working Burden(-0.27%,0.00%...	Maximum Error 0.75%,0.35%,0.20%,0.20%	Maximum Error 0.75%,0.35%,0.20%,0.20%	Pass

Evaluation Standards IEC60044-1 0.2Class **CT Evaluation Pass**

Buttons: Hysteresis Loop, Excitation Data, Excitation Curve, Error Curve Data, Error Curve, Ratio and Phase Angle, Winding Resistance, Secondary Burden, Evaluation Parameters

Accessories :

- PC Software
- Test Leads
- Set Of Clamps
- Power Chord
- Set of Fuse

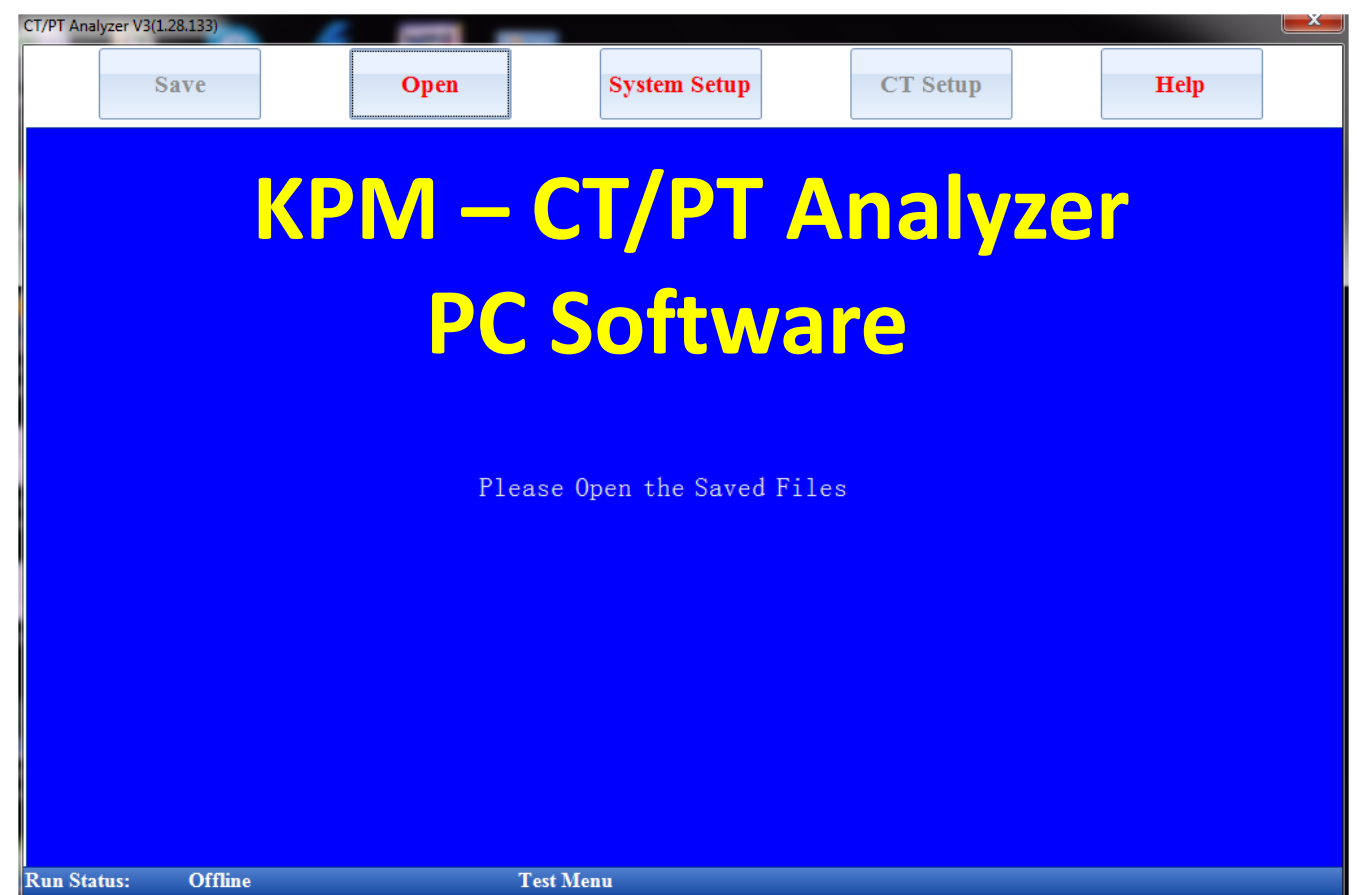

Practical Demonstrations :



2000:1 ,400KV CT ,S/S



6000:1
Generator Bus Duct CT



8000:1 ,
Generator Bus Duct CT



KPM-CT/PT Analyzer



2000:1
400 KV CT

All in One Solution for testing of
CT / PT / CVT



6000:1
Generator Bus Duct CT

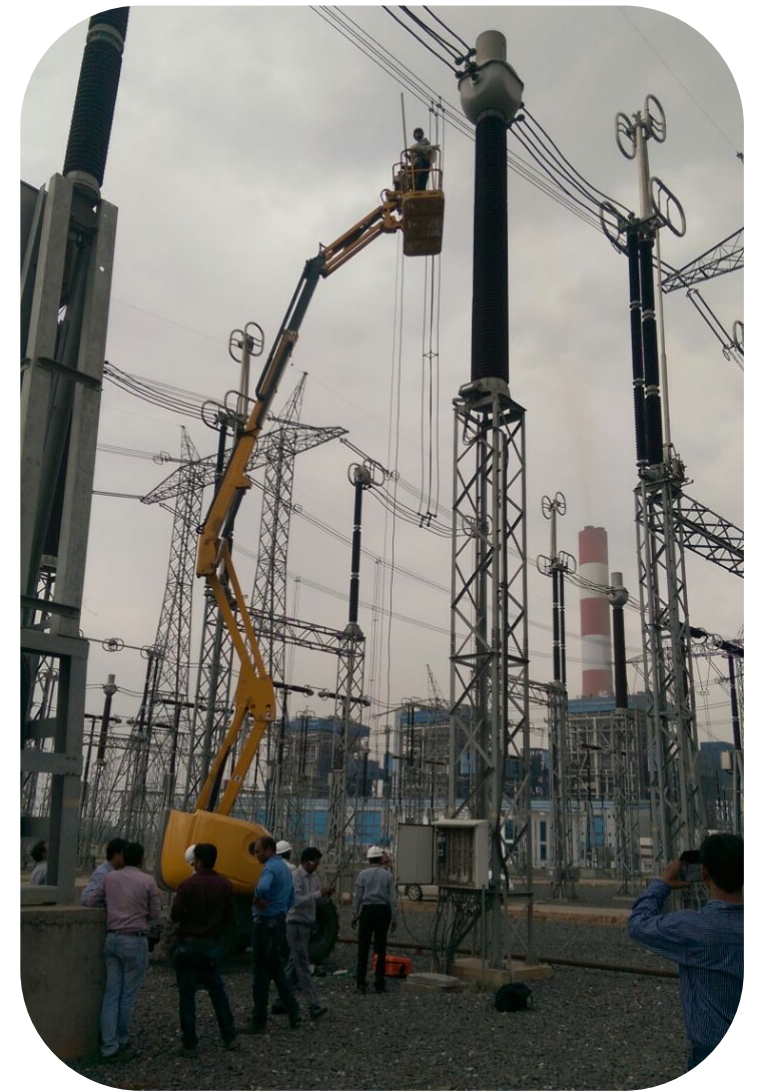

3000:1
765 KV CT

KPM-CT/PT Analyzer with its state of art noise rejection circuitry is capable of testing in high voltage substations with highly inductive environment .

About Us

KPM is a high quality manufacturer & provider of rugged electrical testing equipment for EHV/HV/LV substations. KPM solutions are known for:

- Best in class specifications
- Unique test approach
- Interference rejection capability

Each equipment is supported by advance service center in Gurgaon backed by a team of expert application & service engineers. KPM aims in bringing highest specification products at the doorstep of Indian customers in best rates.

Contact Us

KPM ENGINEERING SOLUTIONS PVT. LTD.
815 A, 8th Floor, Unitech Arcadia, Sec 49,
Gurugram – 122018 ,Haryana
Website : www.kpmtek.com ,
Email : sales@kpmtek.com
Phone No : +91 124 4001088

