



KPM's Earth Tester (KPM-ET30K)

KPM-ET30K Earth Resistance & Soil Resistivity Tester is specially designed and manufactured for measuring earth resistance, soil resistivity, earth voltage, AC voltage. Adopting the latest digital and micro-processing technology, precise 4-pole, 3-pole and simple 2-pole method for earth resistance measurement, importing FFT and AFC technology, with a unique function of anti-interference capability and the ability to adapt to the environment, ET-30K is capable of getting repetitive & reliable results .

KPM-ET30K is widely used in industry for earth resistance, soil resistivity, earth voltage, AC voltage measurement applications.

ET30K Earth Resistance Soil Resistivity Tester is composed of host machine, monitoring software, testing wires, auxiliary ground pillars, communication wires and others. The large LCD display of host machine is with blue backlight and bar graph indicating that can be seen clearly. At the same time it can store 300 sets of data, fulfilling historical inquiry and online real-time monitoring through monitoring software, dynamic display, alarm indicator, and with the functions like historical data access, reading, preservation, report forms, printing and so on

Product DETAILS :-

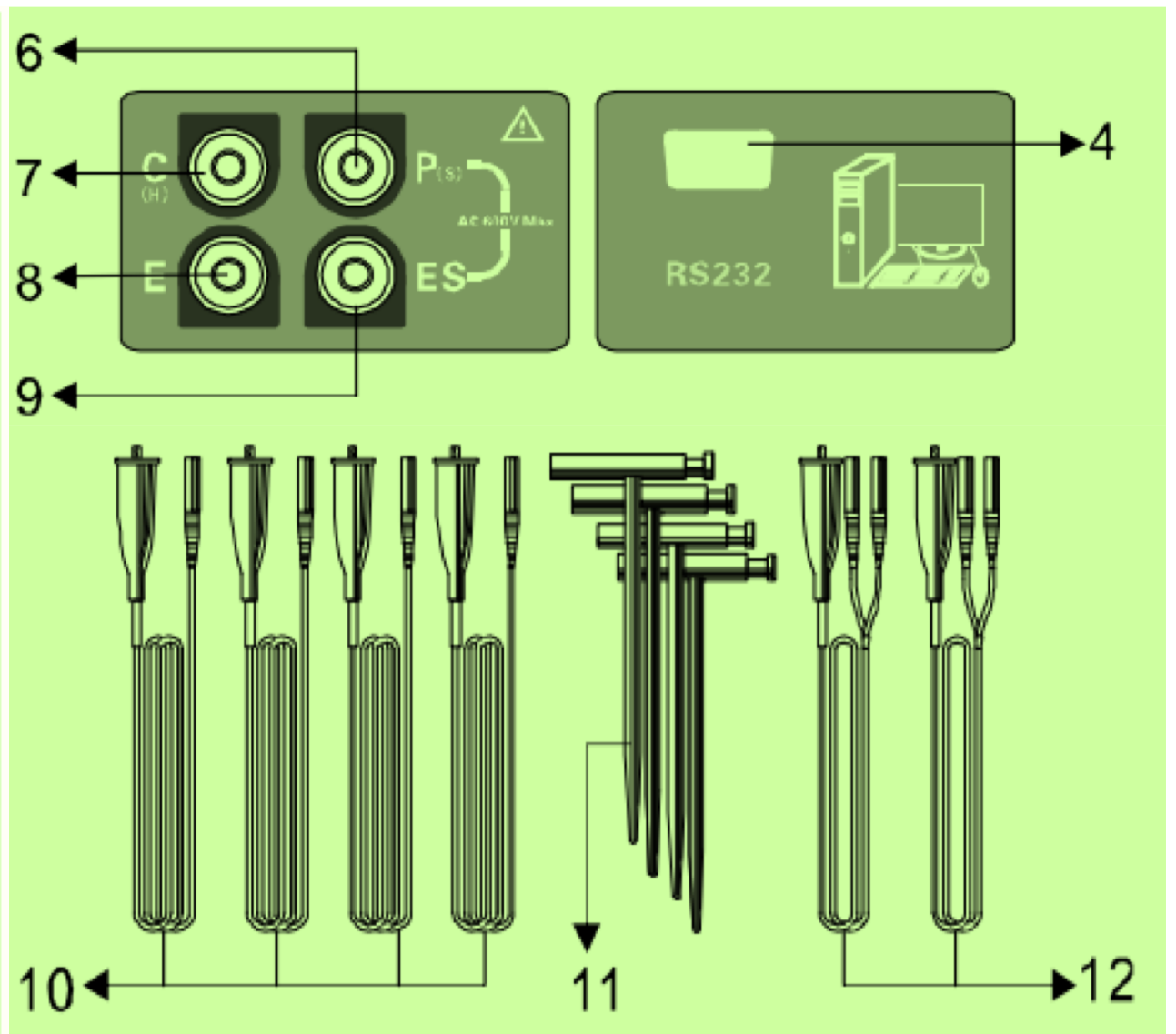
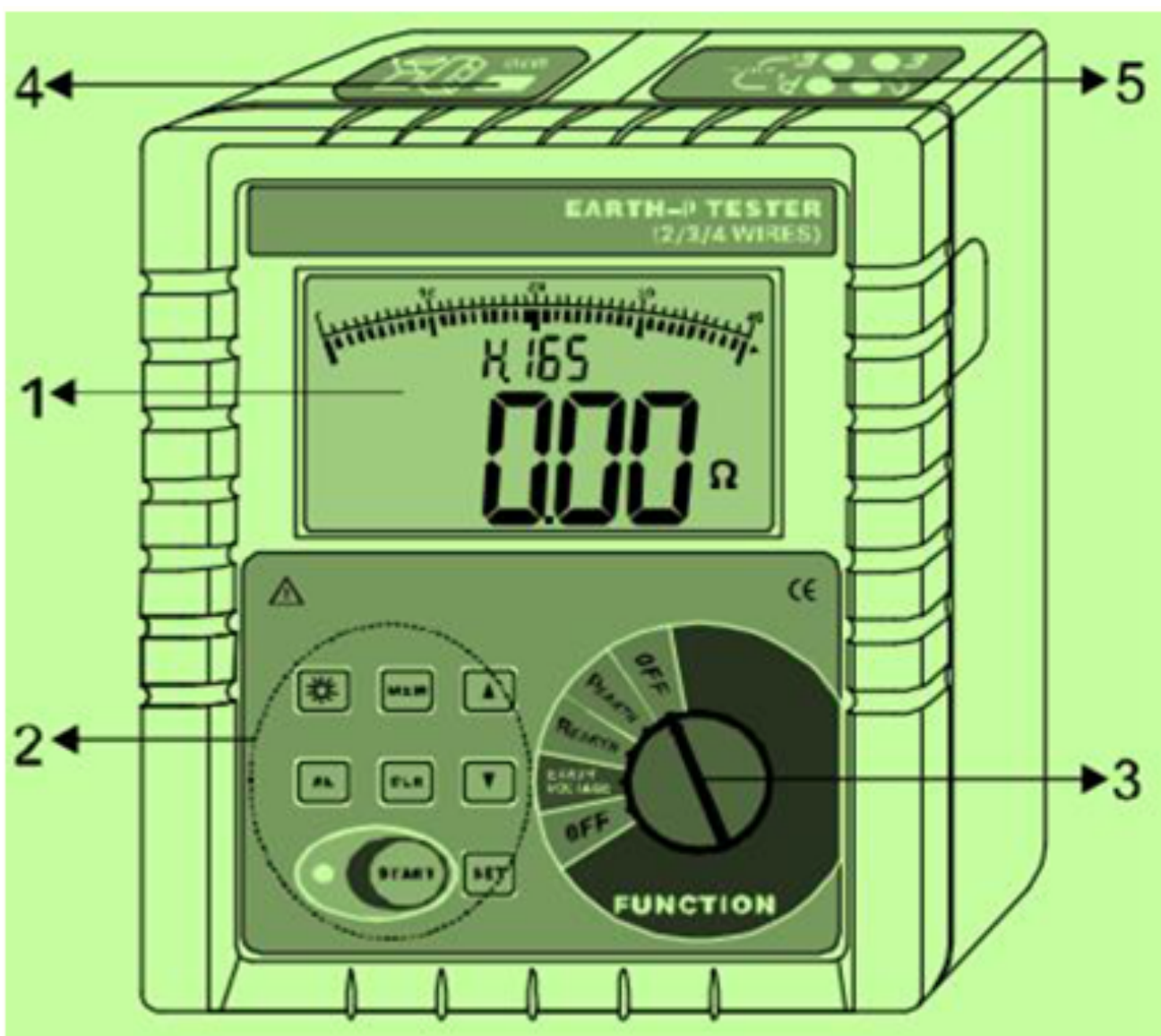

- 1. LCD
- 2. Button area
- 3. Rotary switch for selecting function
- 4. RS232 interface
- 5. Interface of testing wires
- 6. P(S) interface: Voltage electrode
- 7. C(H) interface: Current electrode

- 8. E interface: Earth electrode
- 9. ES interface: Auxiliary earth electrode
- 10. Standard test wires
- 11. Auxiliary earthing spikes
- 12. Simple test wires

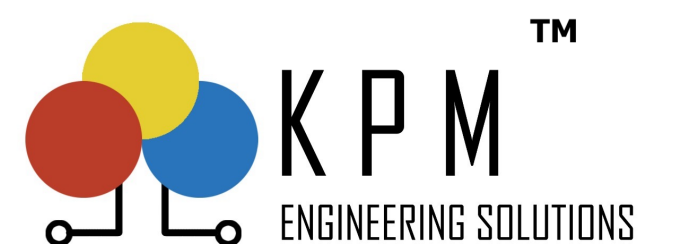

KPM's Earth Tester (KPM-ET30K)

Principle of Earth Tester

To understand the principle of earth tester, consider Fig(a); With increased distance from an electrode, the earth shells are of greater surface area and therefore of lower resistance. Now, assume that you have three spikes driven into the earth some distance apart and a voltage applied, as shown in Fig(a). The current between spikes 1 and 2 is measured by an ammeter; the potential difference (voltage) between spikes 1 and 3 is measured by a voltmeter.

If spike 3 is located at various points between spikes 1 and 2, preferably in a straight line, you can get a series of voltage readings. By Ohm's Law ($R = E/I$) you can determine the earth resistance at any point measured. For example, if the measured voltage E between spikes 1 and 3 is 30 V and the measured current I is 2 A, the resistance of the earth R at that point would be 15 Ω .

The series of resistance values can be plotted against distance to obtain a curve Fig(b). Note that as spike 3 is moved away from spike 1, the resistance values increase, but the amount of increase gets less and less until a point is reached where the rate of increase becomes so small that it can almost be considered constant (20 Ω in Fig. b). The earth shells between the two spikes (1 and 3) have so great a surface area that they add little to the total resistance. Beyond this point, as spike 3 approaches the earth shells of spike 2, resistance gradually picks up. Near spike 2, the values rise sharply.

Soil resistivity measurement is called as "four point method" and measuring earth resistance is called as "three point method"

Key Specifications

- **ALARM:** - ET30K has alarm feature, user can get alarm when limit exceeds.
- **AUTOMATIC CALCULATION OF RESISTIVITY:** In the traditional equipment we have to calculate the soil resistivity manually whereas ET30K calculates the final value automatically.
- **AUTOMATIC FREQUENCY CONTROLLER:** ET30K automatically selects the testing frequency with the least amount of noise enabling you to get a clear reading.

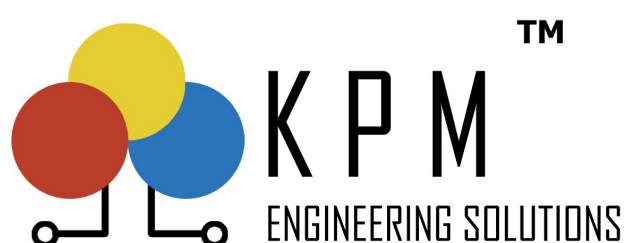

(a)

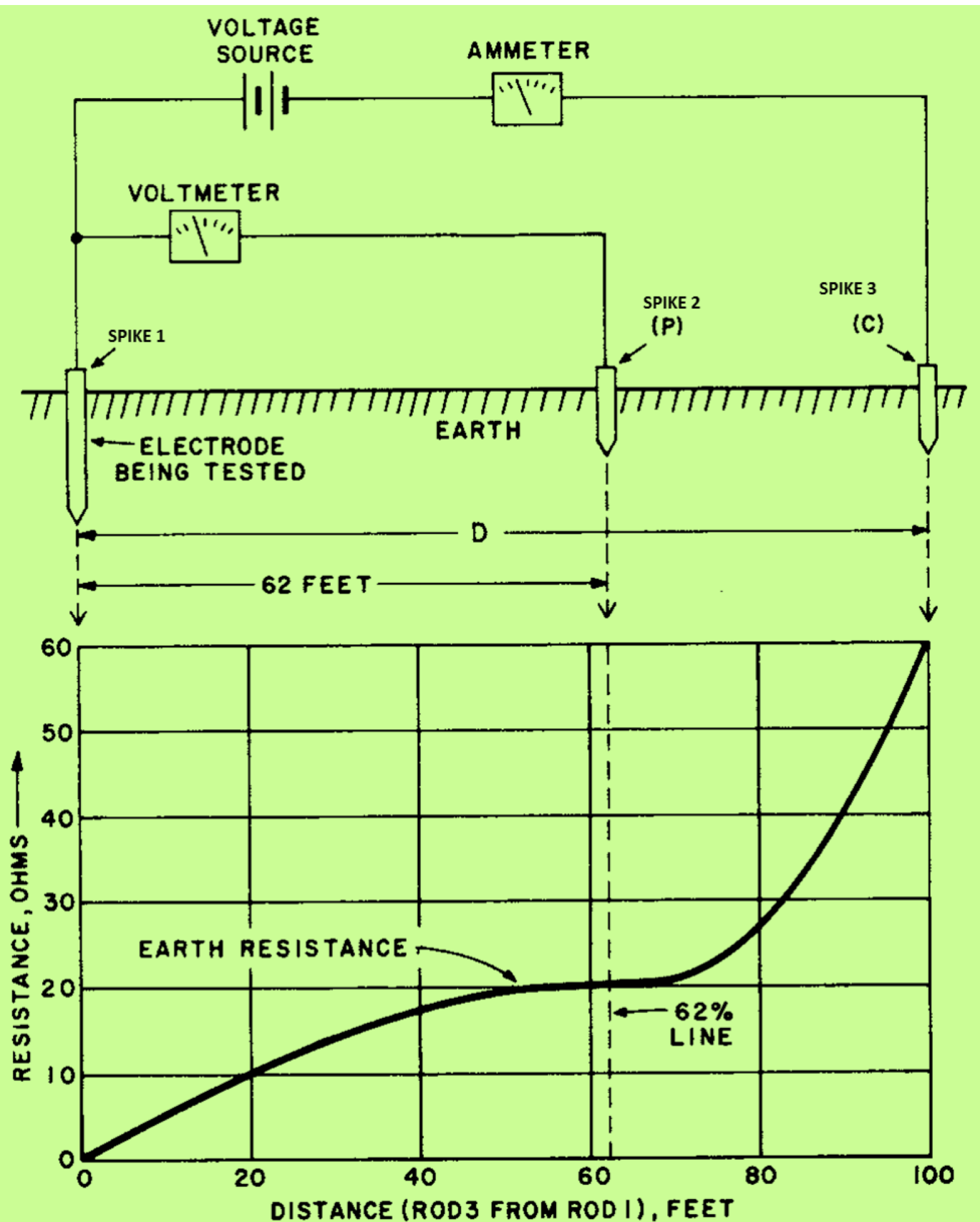

(b)



KPM's Earth Tester (KPM-ET30K)

Technical Specifications:

Earth Resistance Range	0.01- 30K Ω		Working Temperature and Humidity	-10°C to 55°C ; below 95%RH noncondensing
Range	Resolution	Accuracy	Storage Temperature and Humidity	-20°C to 60°C ; below 95%RH noncondensing
0.00 Ω -30.00 Ω	0.01 Ω	$\pm 2\%rdg\pm 3dgt$	LCD Screen	4 Digits LCD display, Blue screen back lit Window dimension 124mmx67mm
30.0 Ω -300.0 Ω	0.1 Ω	$\pm 2\%rdg\pm 3dgt$	Insulation Resistance	Over 20M Ω (Between circuit and enclosure it is 500V)
300 Ω -3000 Ω	1 Ω	$\pm 2\%rdg\pm 3dgt$	Withstanding Voltage	AC 3700V/rms (Between circuit & enclosure)
3.00k Ω -30.00k Ω	10 Ω	$\pm 4\%rdg\pm 3dgt$	Open Circuit test voltage	AC 35V max.
Soil Resistivity Range	0.00 Ω m-9000k Ω m		Electrode Distance Range	1m-100m
Range	Resolution	Accuracy	Protection Type	IEC 61010-1 (CATIII 300V,CAT IV 150V, Pollution 2), IEC 61010-031, IEC 61557-1, IEC 61557-5,JJG 366-2004
0.00 Ω -99.99 Ω m	0.01 Ω	According to the precision of R	Electromagnetic feature Shift	IEC61326 (EMC)
100.0 Ω m-999.9 Ω m	0.1 Ω		Earth resistance:	0.00 Ω -30.00 Ω automatic shift
1000 Ω m-9999 Ω m	1 Ω		Soil resistivity:	0.00 Ω m-9000k Ω m, automatic shift
10.00k Ω m-99.99k Ω m	10 Ω	($\rho=2\pi aR$	Tester Weight	1443g (With batteries)
100.0k Ω m-999.9k Ω m	100 Ω m	a:1 m-100m,	Dimension	LxWxT: 215mmx190mmx95mm
1000k Ω m-9000k Ω m	1k Ω m	$\pi=3.14$)	Test frequency	128Hz/111Hz/105Hz/94Hz (AFC)
Earth Voltage			Low Battery Indication	When Battery Voltage decreases to about 7.5V, battery voltage low icon will display, reminding to replace battery
Range	Resolution	Accuracy	Memory Full Indication	MEM symbol blinks when all 300 sets memory is full
AC 0.0-600V	0.1V	$\pm 2\%rdg\pm 3dgt$	Over Range Indication	Exceeding measuring range overflow function 'OL' icon display
Stored Data	300 Sets		Power Consumption	Measurement; about 100mA(Backlight Shut off)
Interference Identification	Recognize interface signal automatically. "NOISE" icon display when interface voltage exceed 5V.		Accessories	Meter: 1 piece, Standard test wire 4 wires, Simple test wire 2 wires, Auxillary Earthing spike 4 spikes Meter Suitcase: 1 Piece
Measuring indicator	LED flash indicator, LCD count down display, Progress Bar indicator			
RS232 Interface	Possess RS232 interface, software supervision ,storage data can be uploaded to computer, saved or printed			
Function	Measurement of 2/3/4- Pole earth resistance, Soil resistivity, earth Voltage, AC Voltage			
Power Supply	DC 9V (Dry Rechargeble battery R14S 1.5V 6 Pcs continuous standby for 300 Hrs)			
Measuring Rate & Time	Earth Voltage about 3 times/second Earth resistance, soil resistivity about 5 seconds/time			
Alarm Sound and Light	"When measuring value exceeds alarm setting value there is alarm			

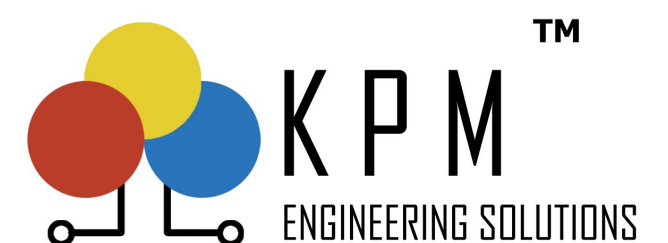

KPM's Earth Tester (KPM-ET30K)

Application Diagrams:

Earth Tester Circuit

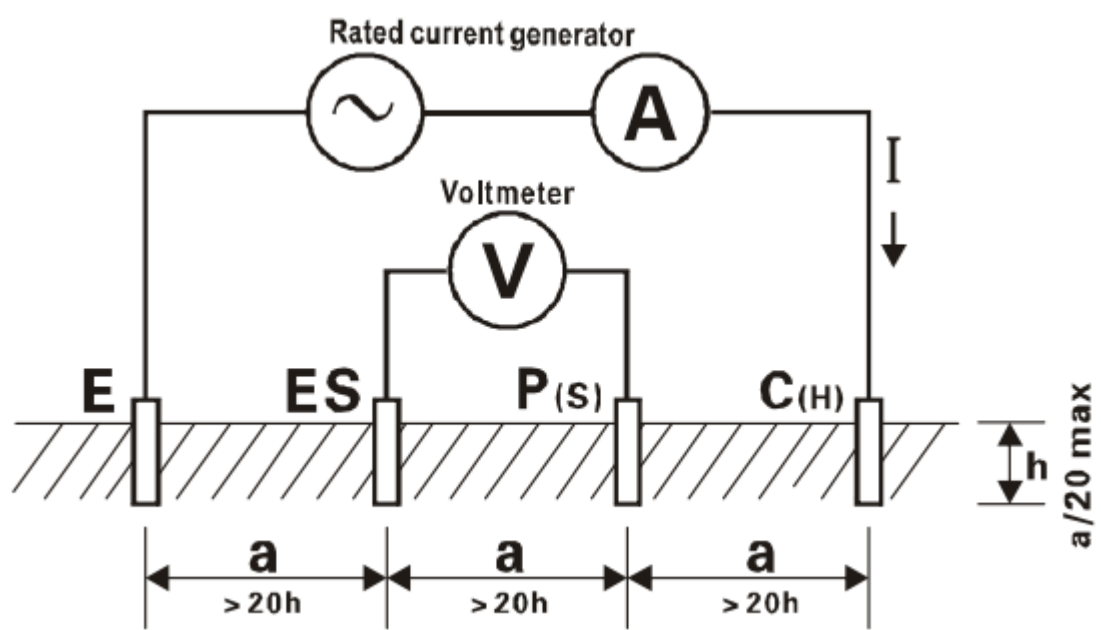

PC Report Manager Software

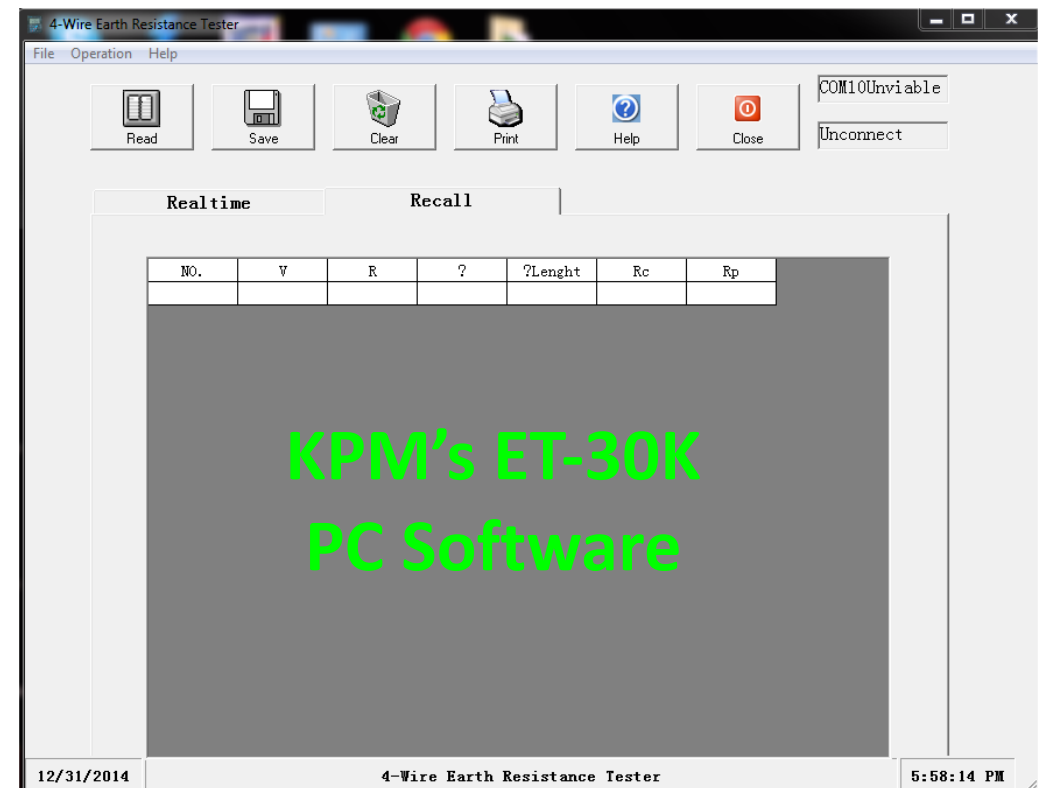

Three Wire Earth Measurement:

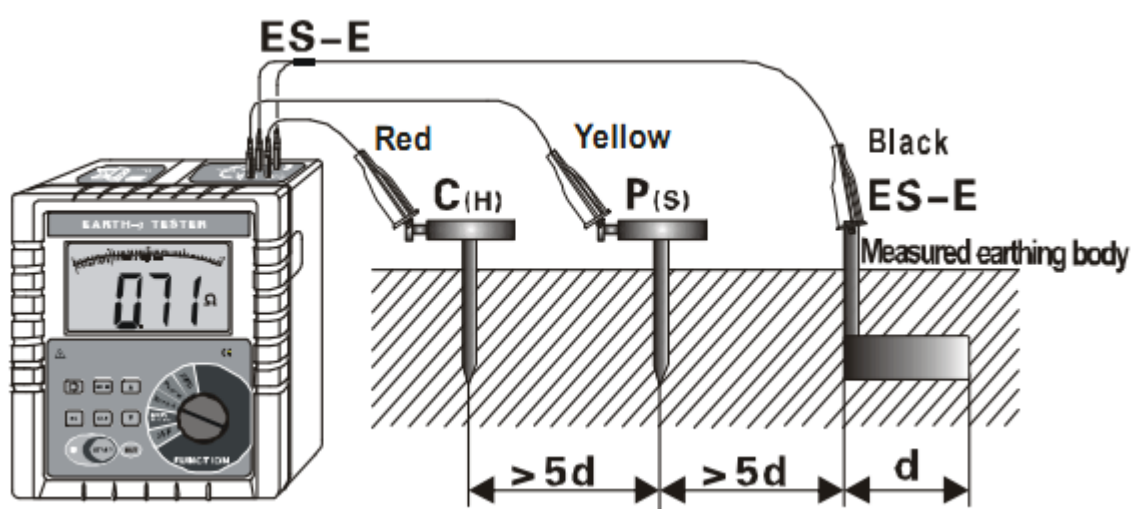

Four Wire Earth Measurement

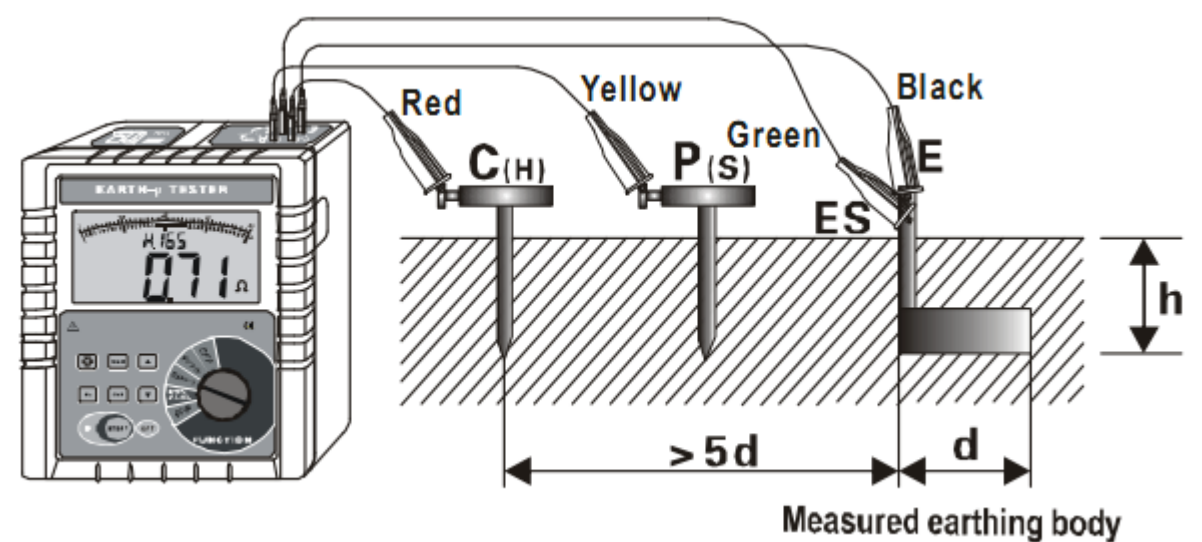

Soil Resistivity Measurement:

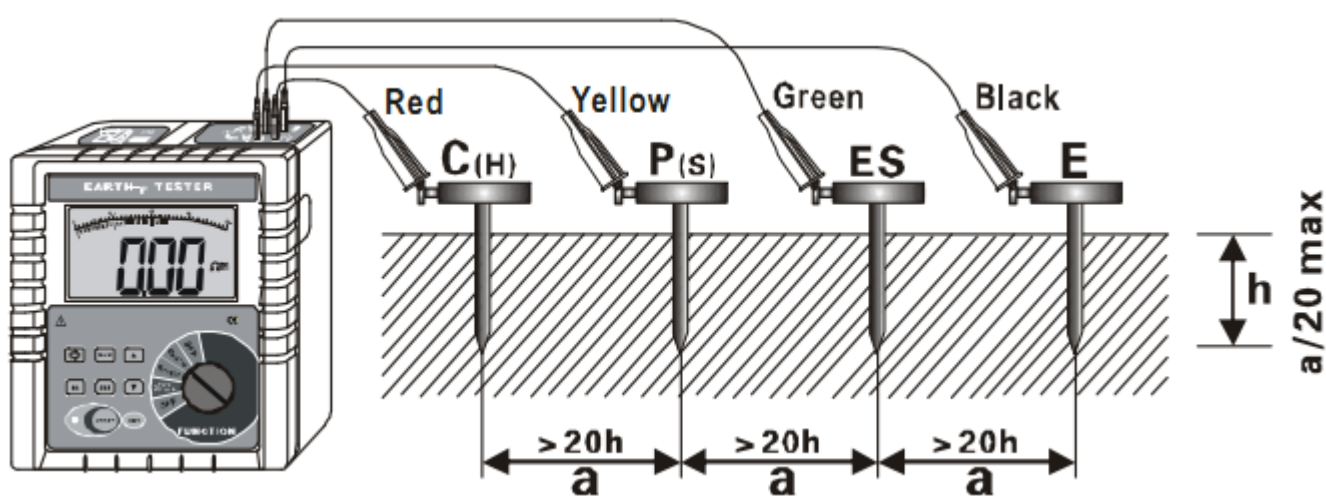

Voltage Measurement:

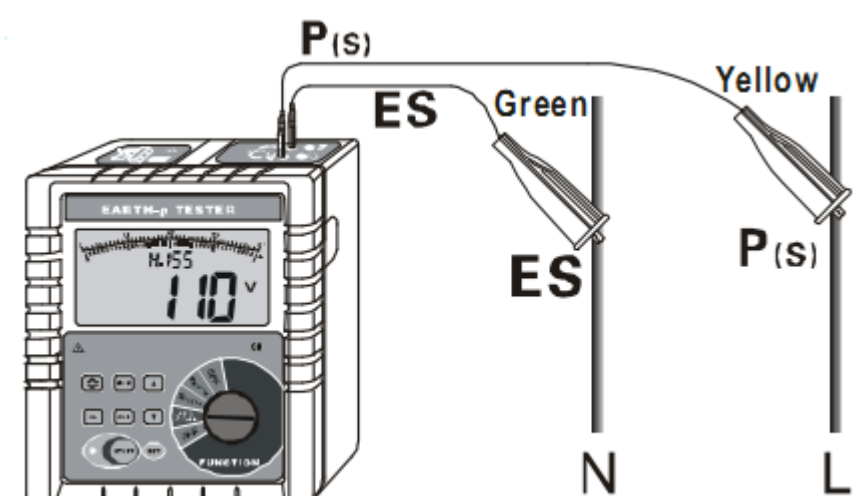

KPM's Earth Tester (KPM-ET30K)

Diagrams:

Ground Resistance Measurement:

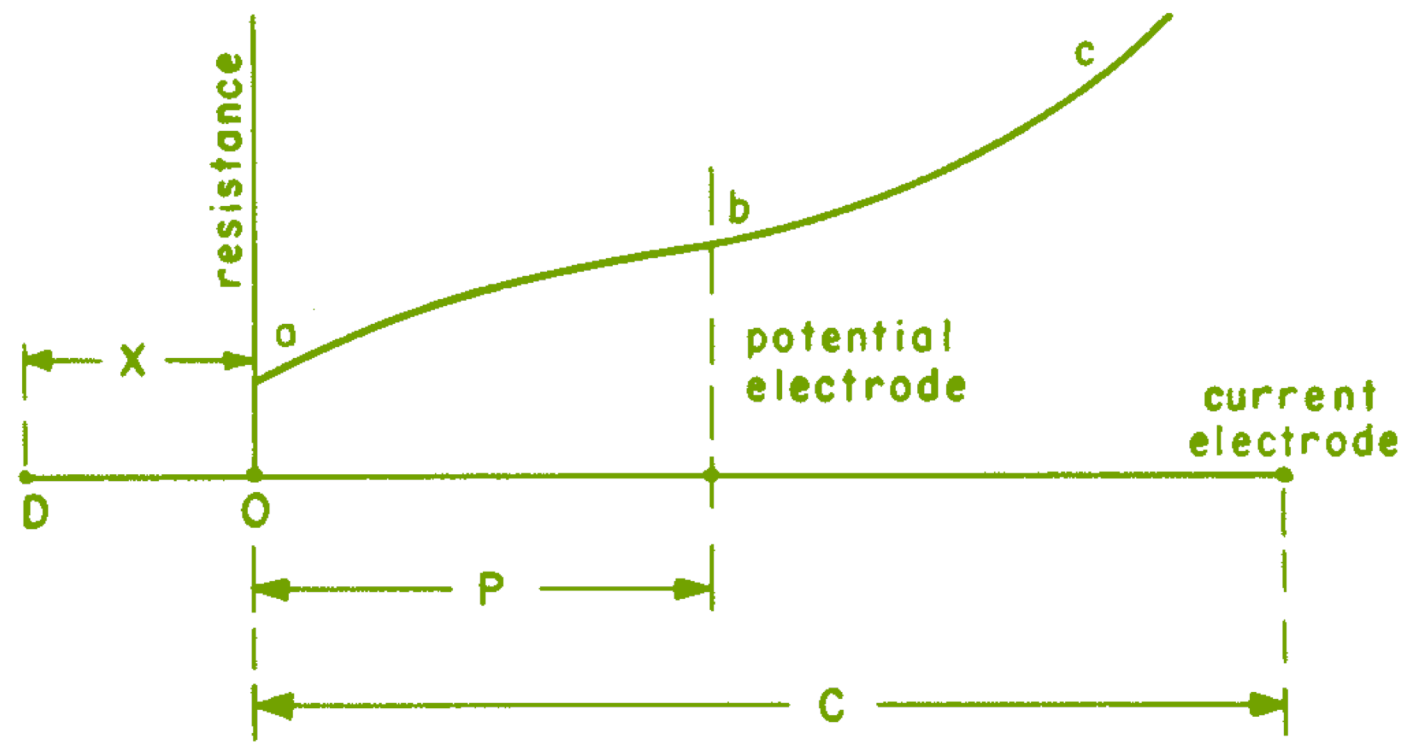
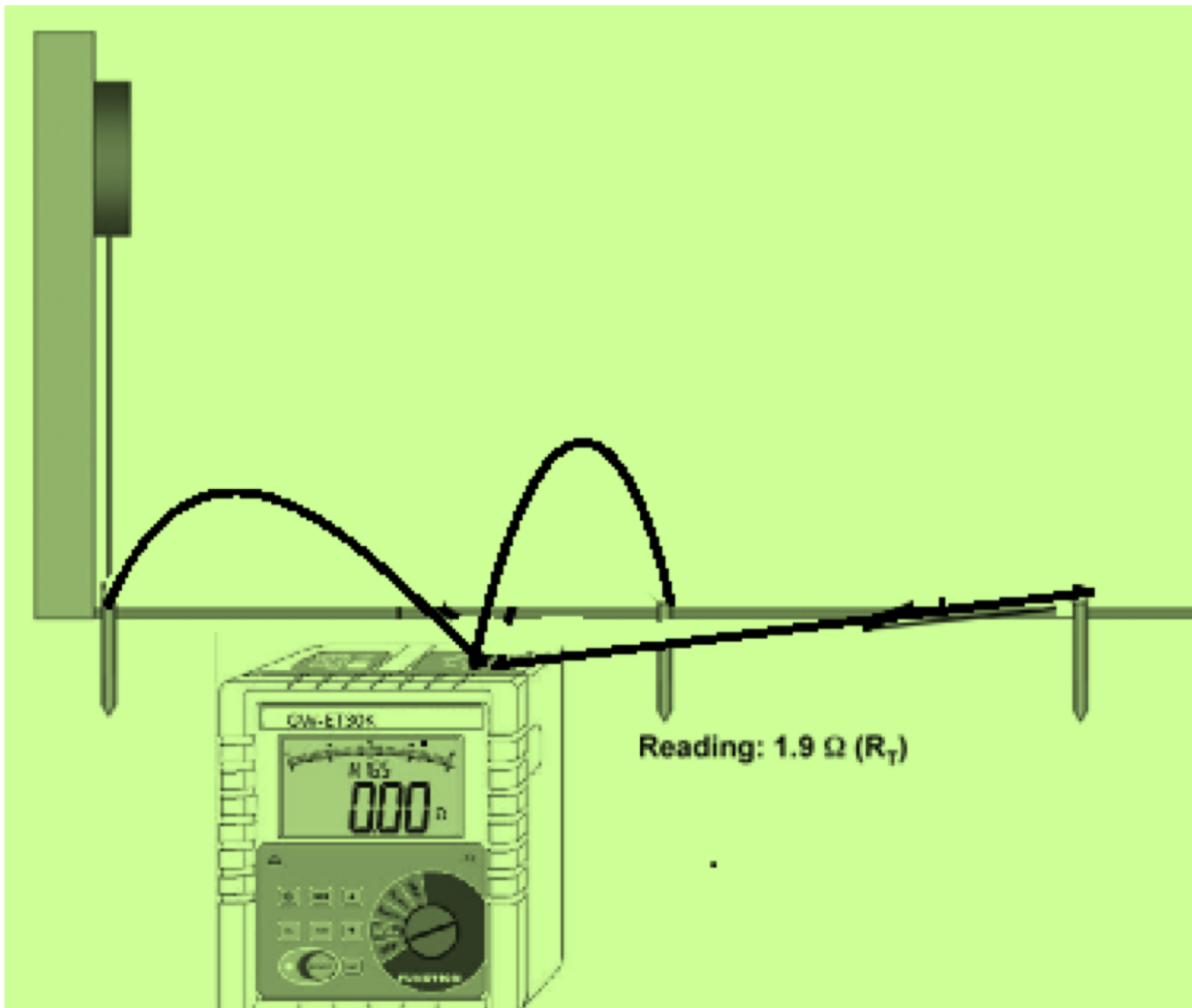

Where,

"O" - the starting point,

"P" - variable distance to the potential lead,

"C" - distance to the current lead.

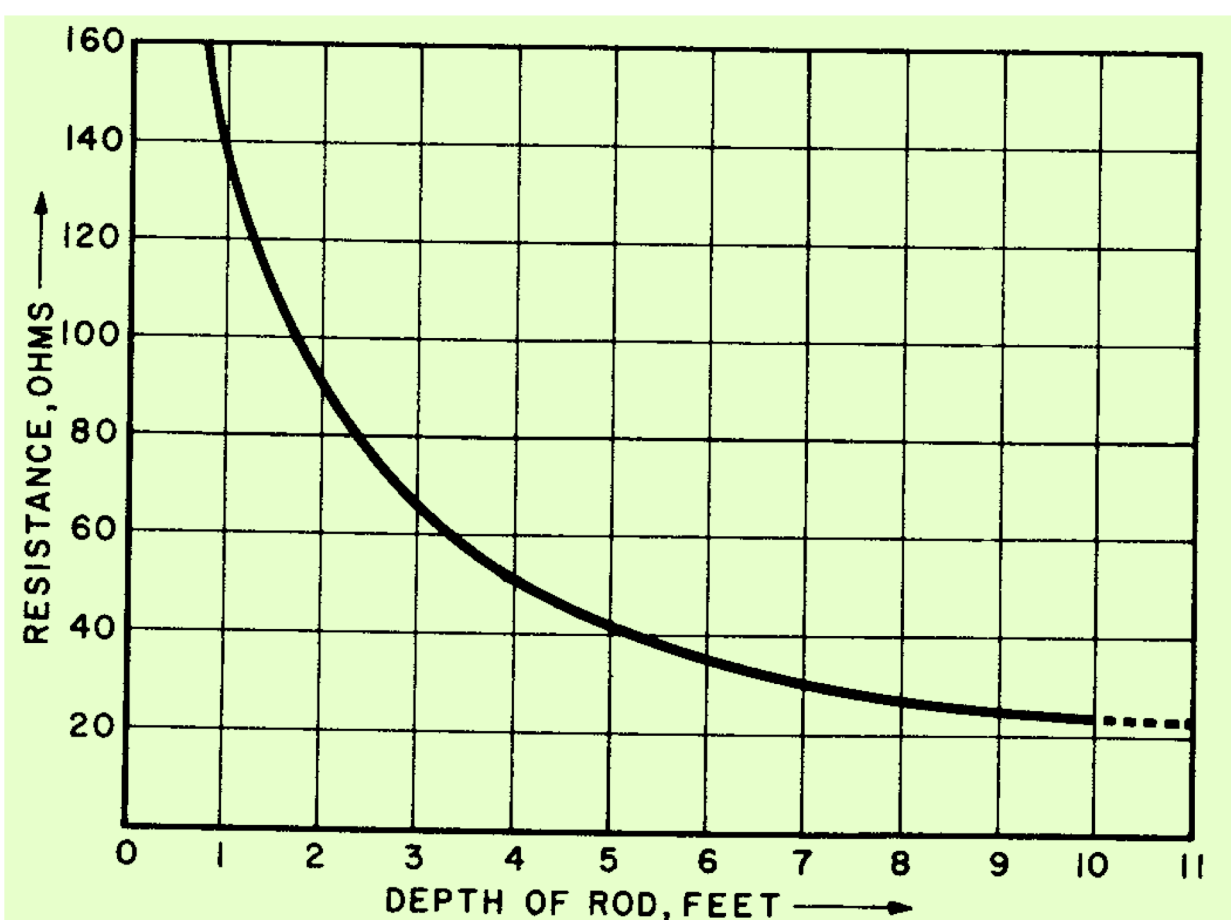

Fig: Earth resistance decreases with the depth of the rod